

전격방지내장

전원

이상

용접



PWR

WARN

WELD



NS 웨딩

내쇼날시스템(주)

National System Co., Ltd.

TEL : (051)305-4030~5



용접전류(A)
MASTER (A)

NS WELDING
INVERTER DC-ARC

NSAX 1800

-METAL

+HOLDER

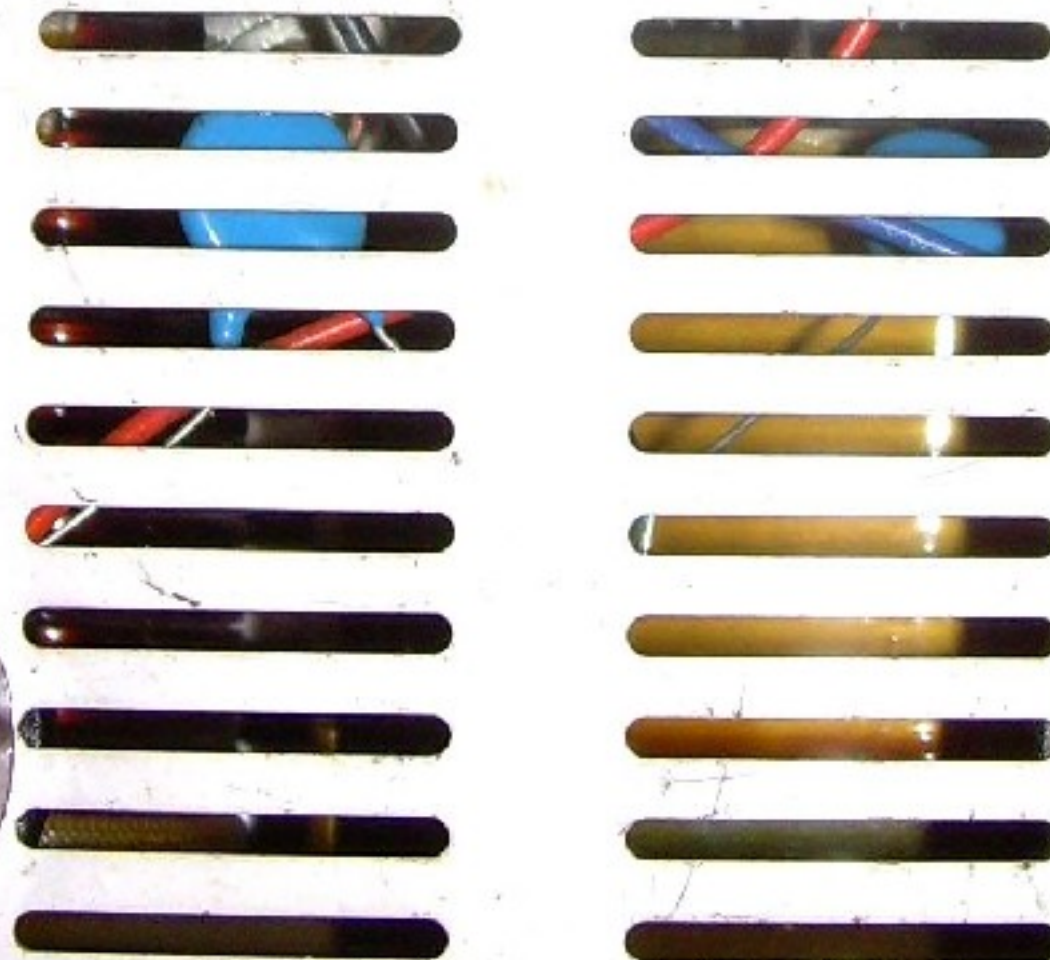

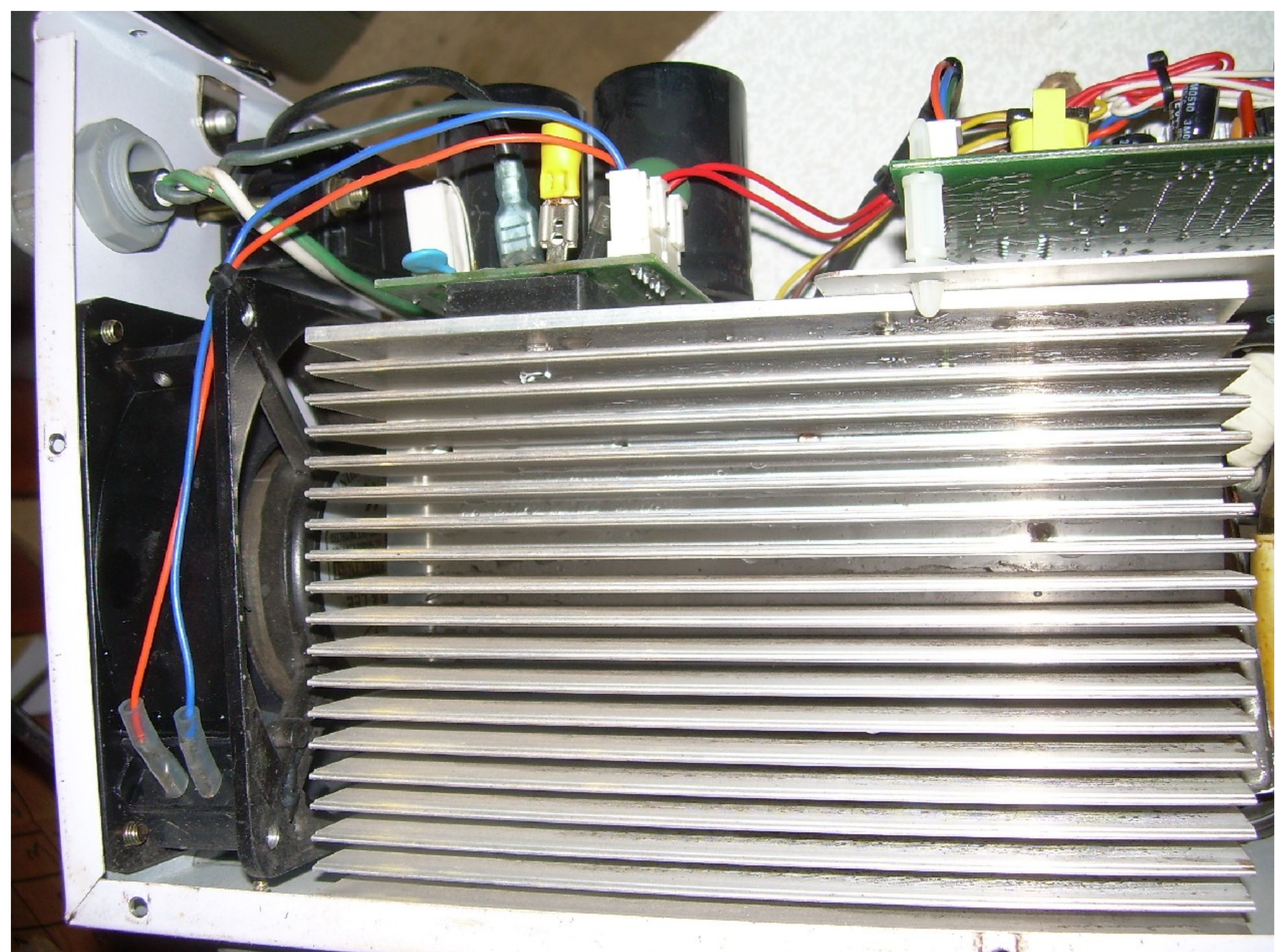

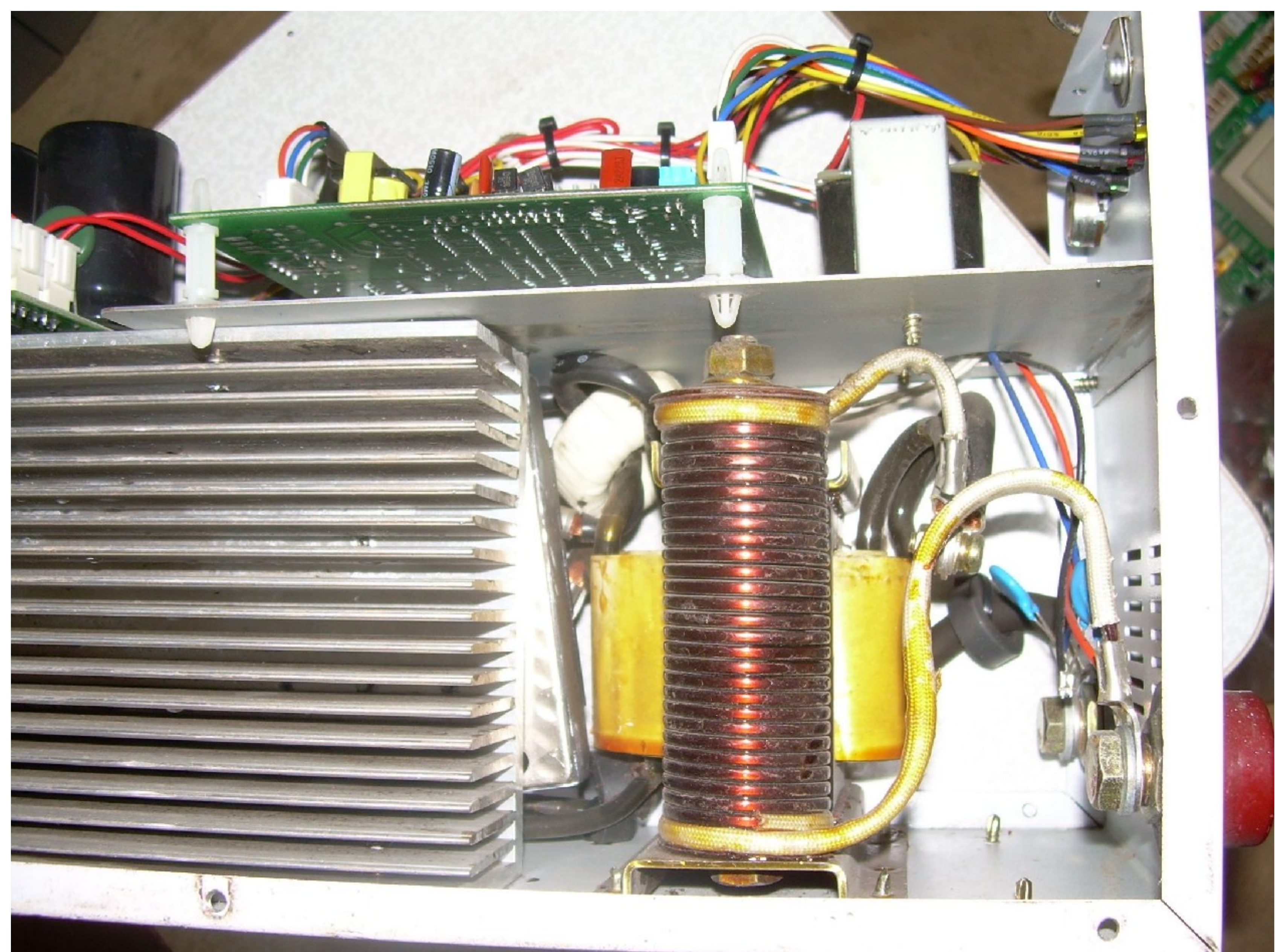

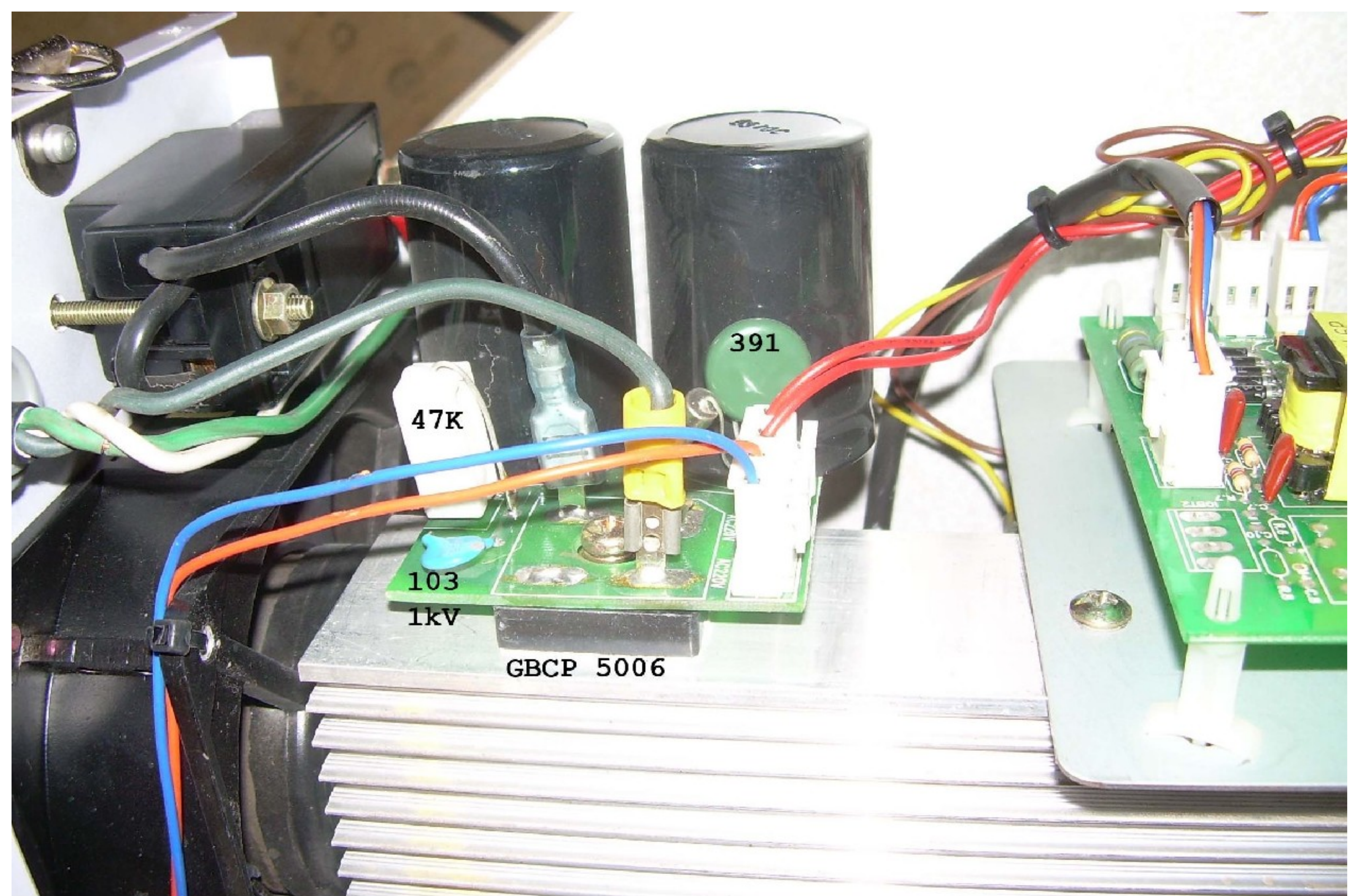

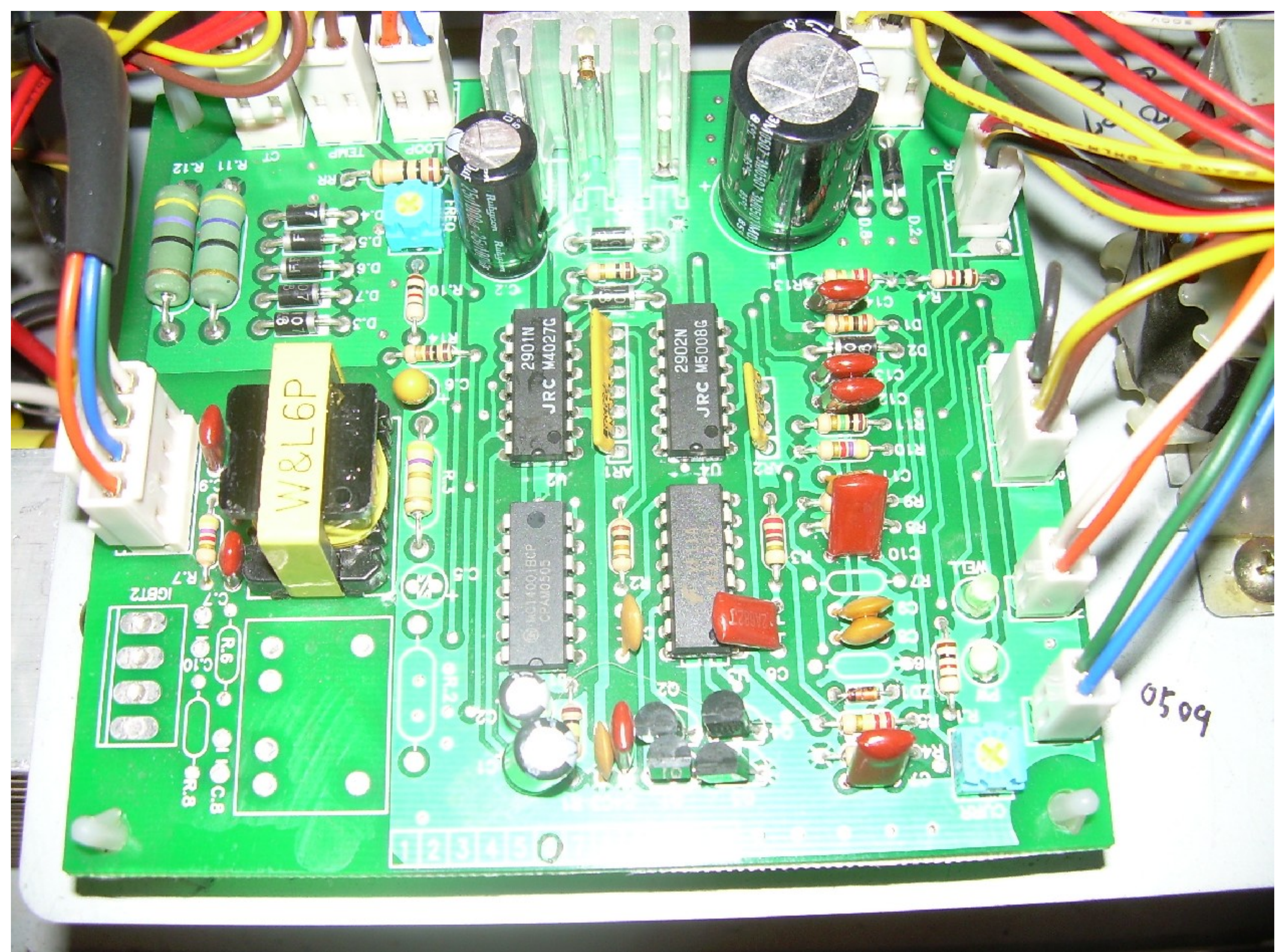

0509

1 2 3 4 5 0

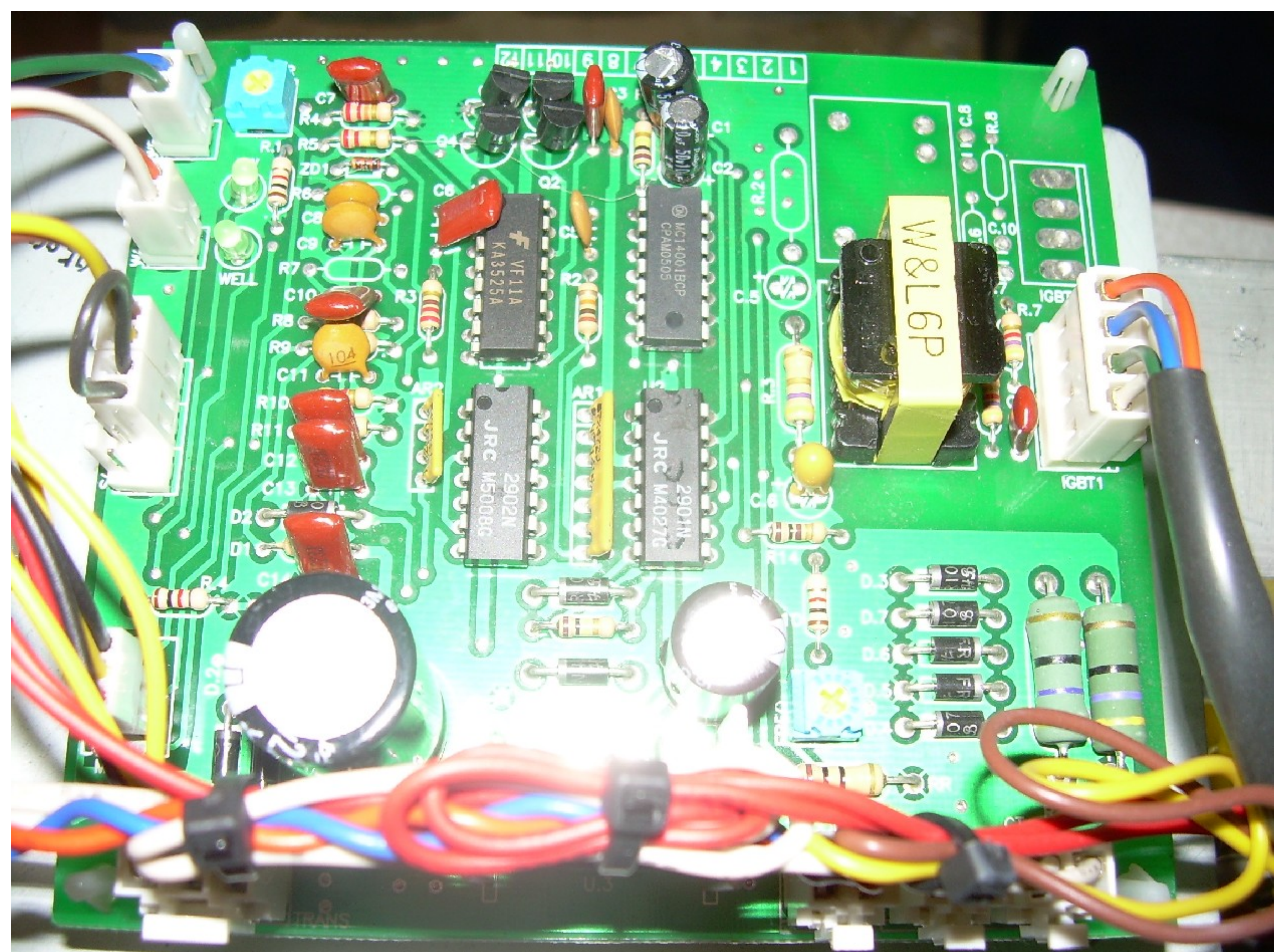

4.7M
250V

2 шт.
3.3m 630V



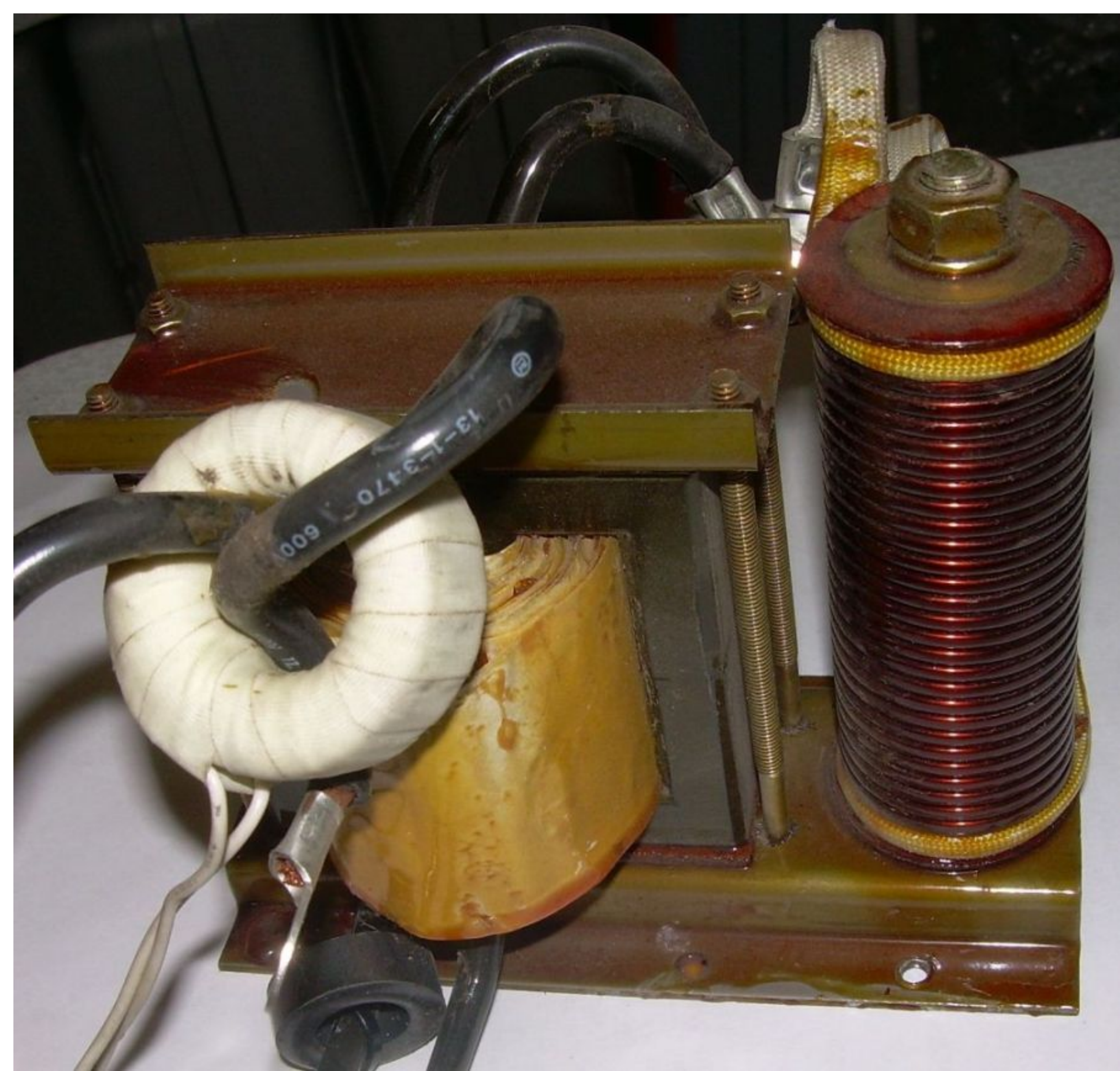

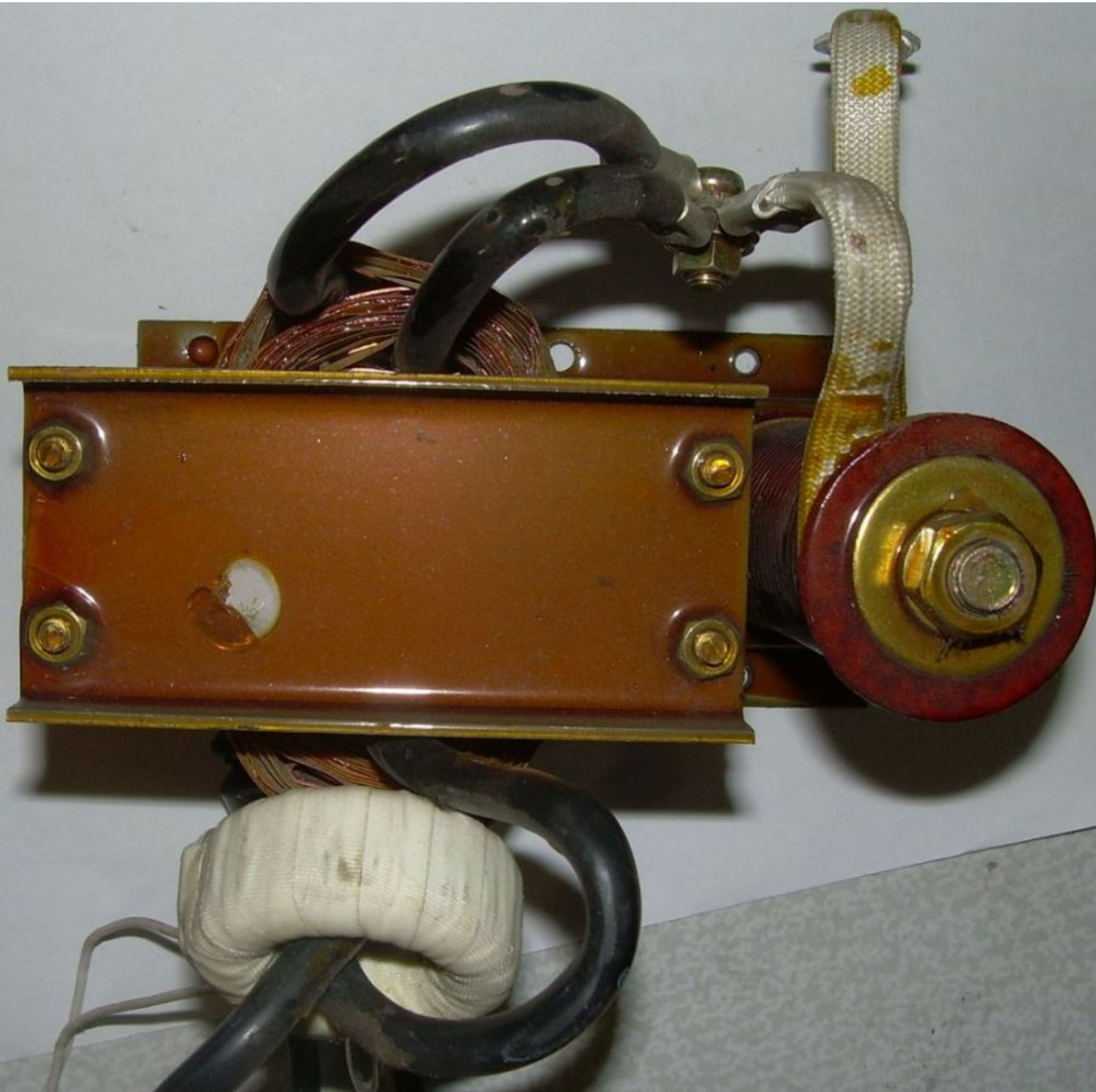

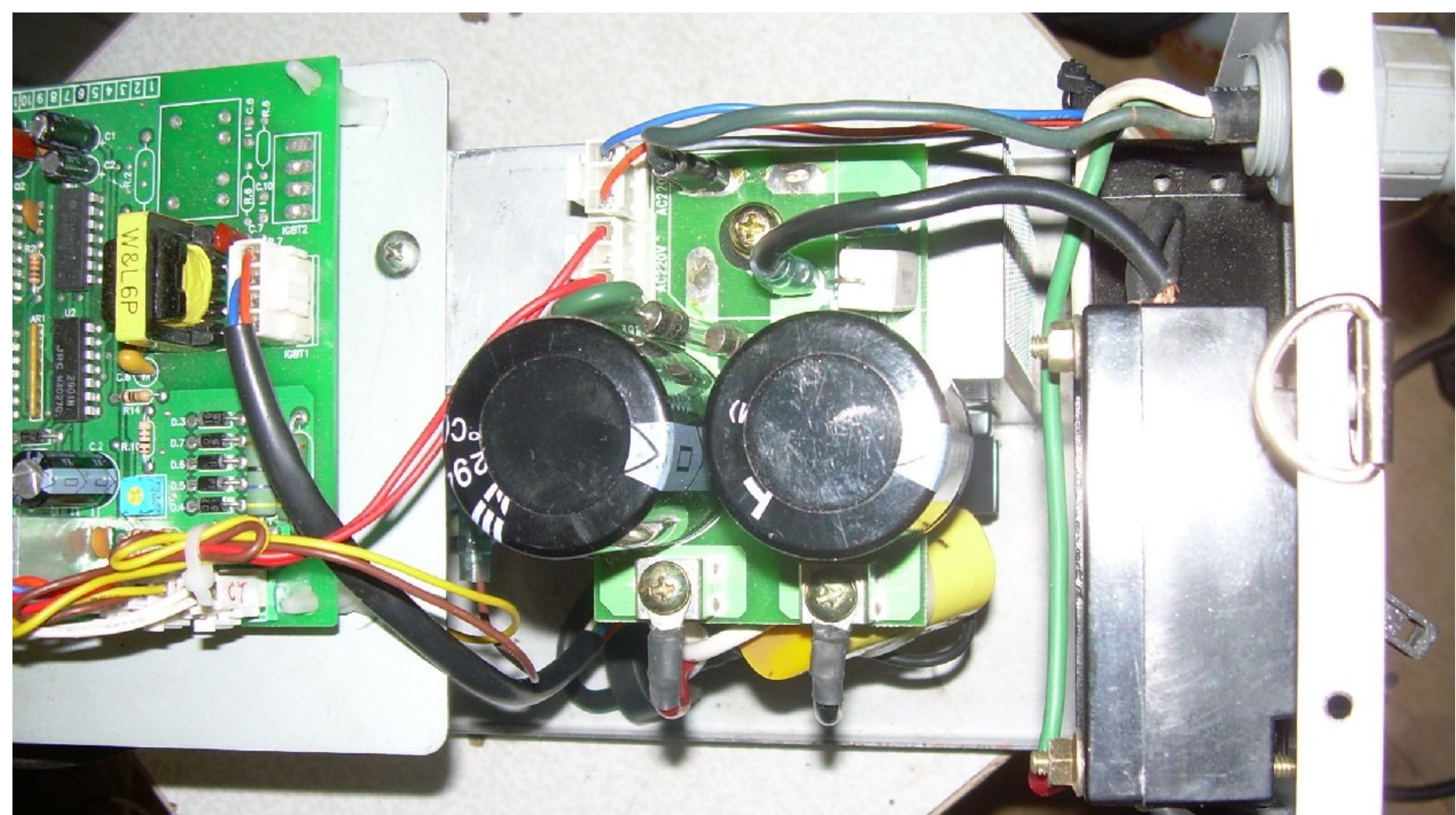

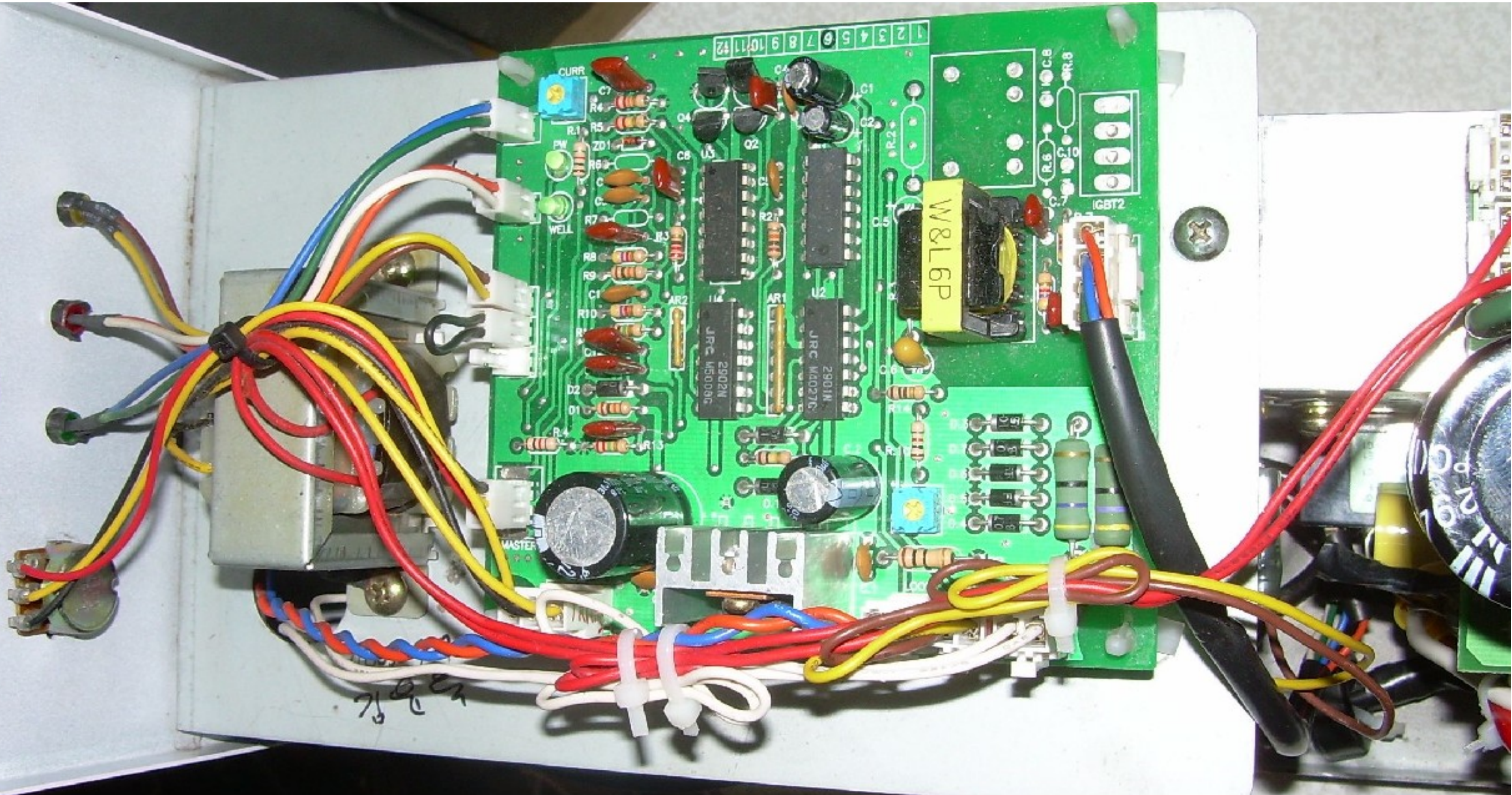

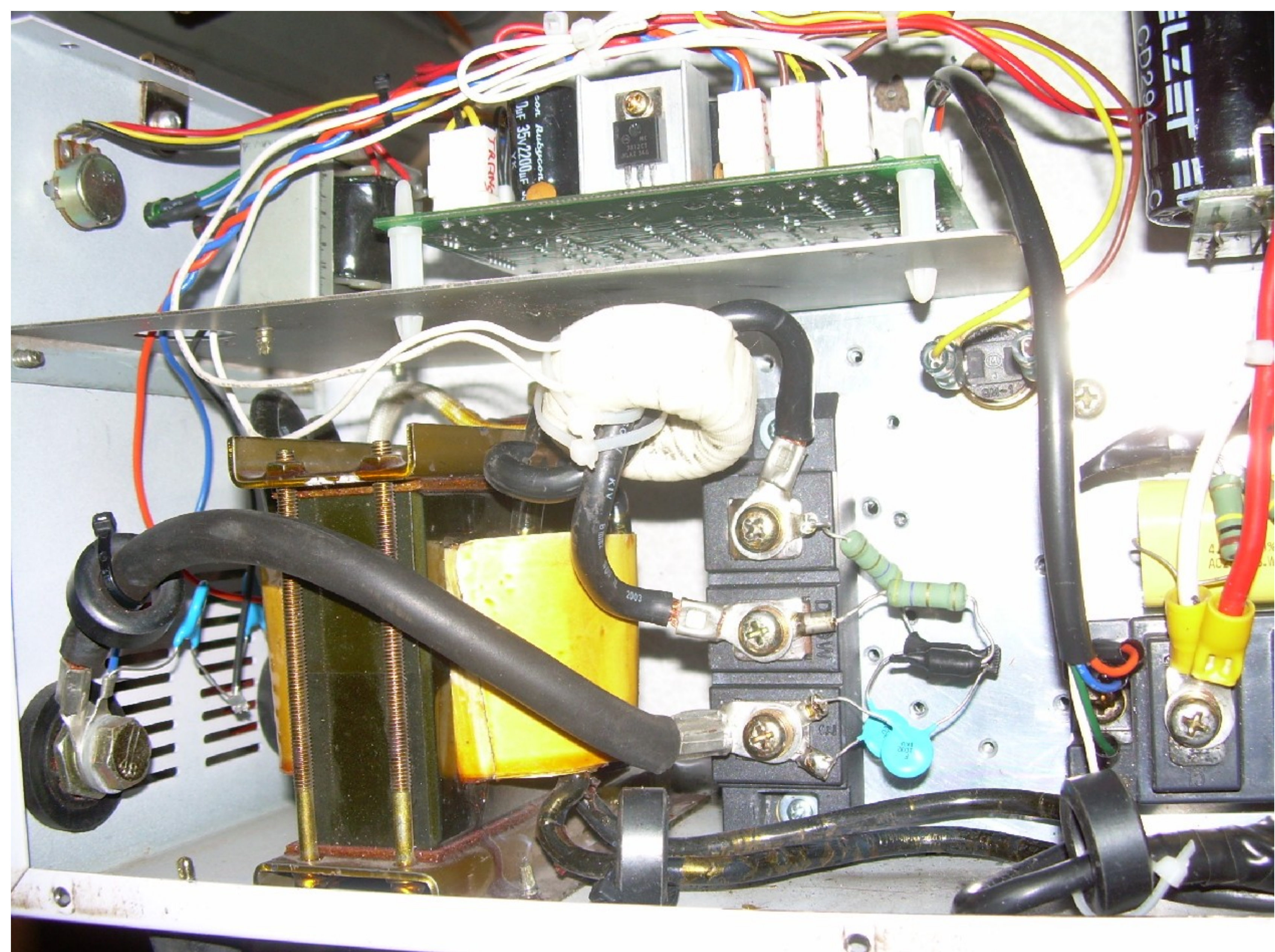

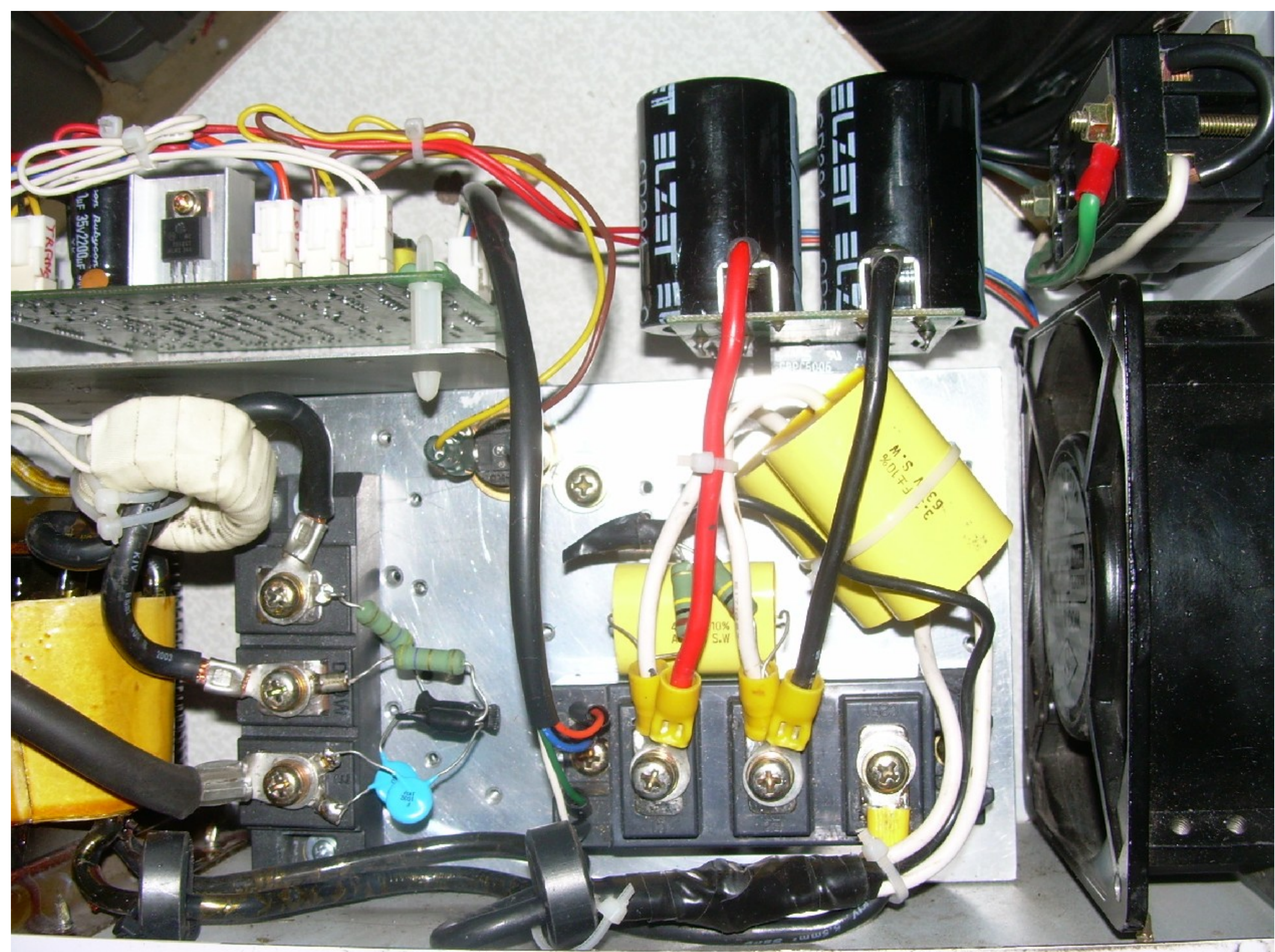

Датчик QMIN 2015 N85
температуры

04/11/2007

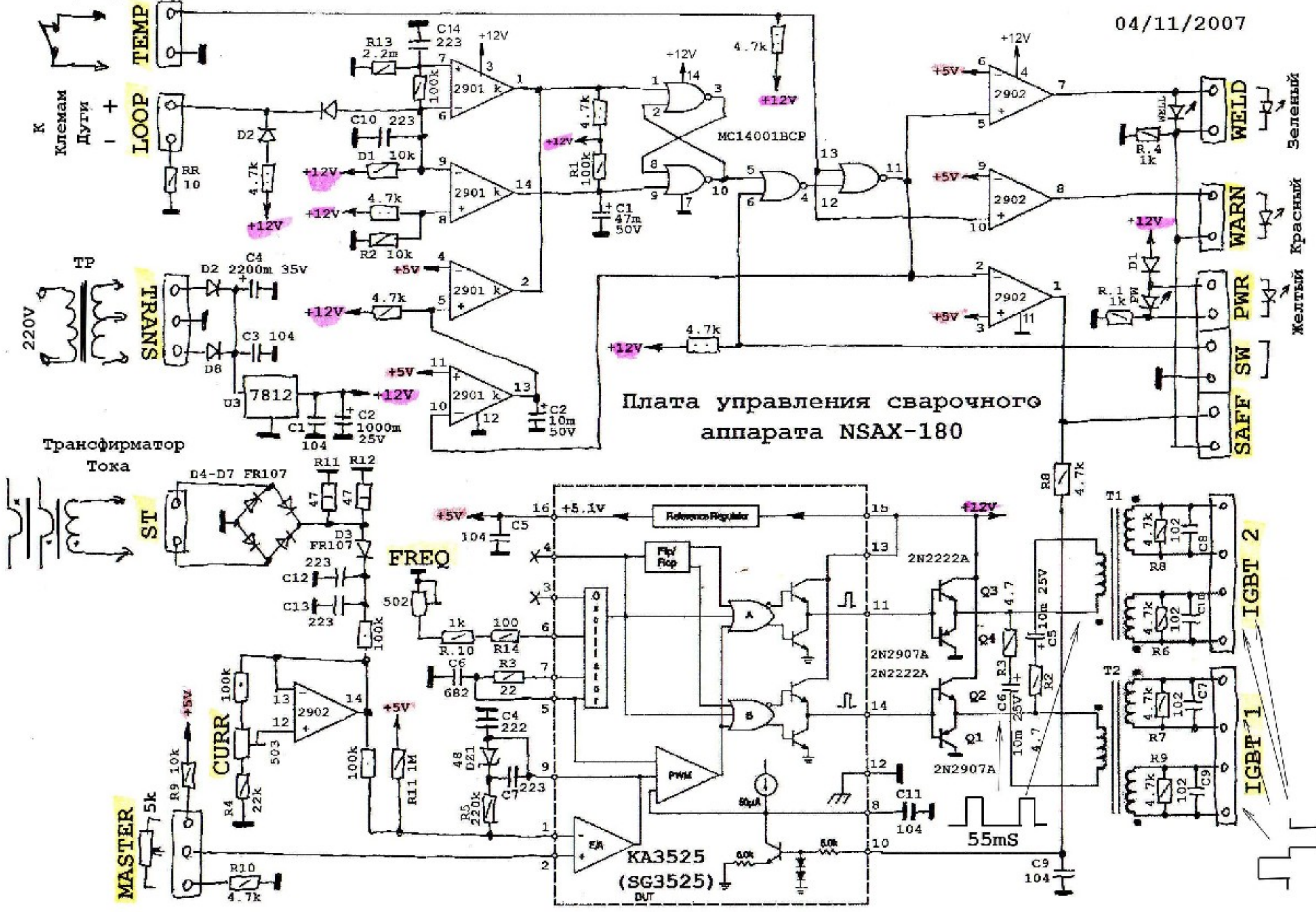

Выходной каскад сварочника NSAX-180

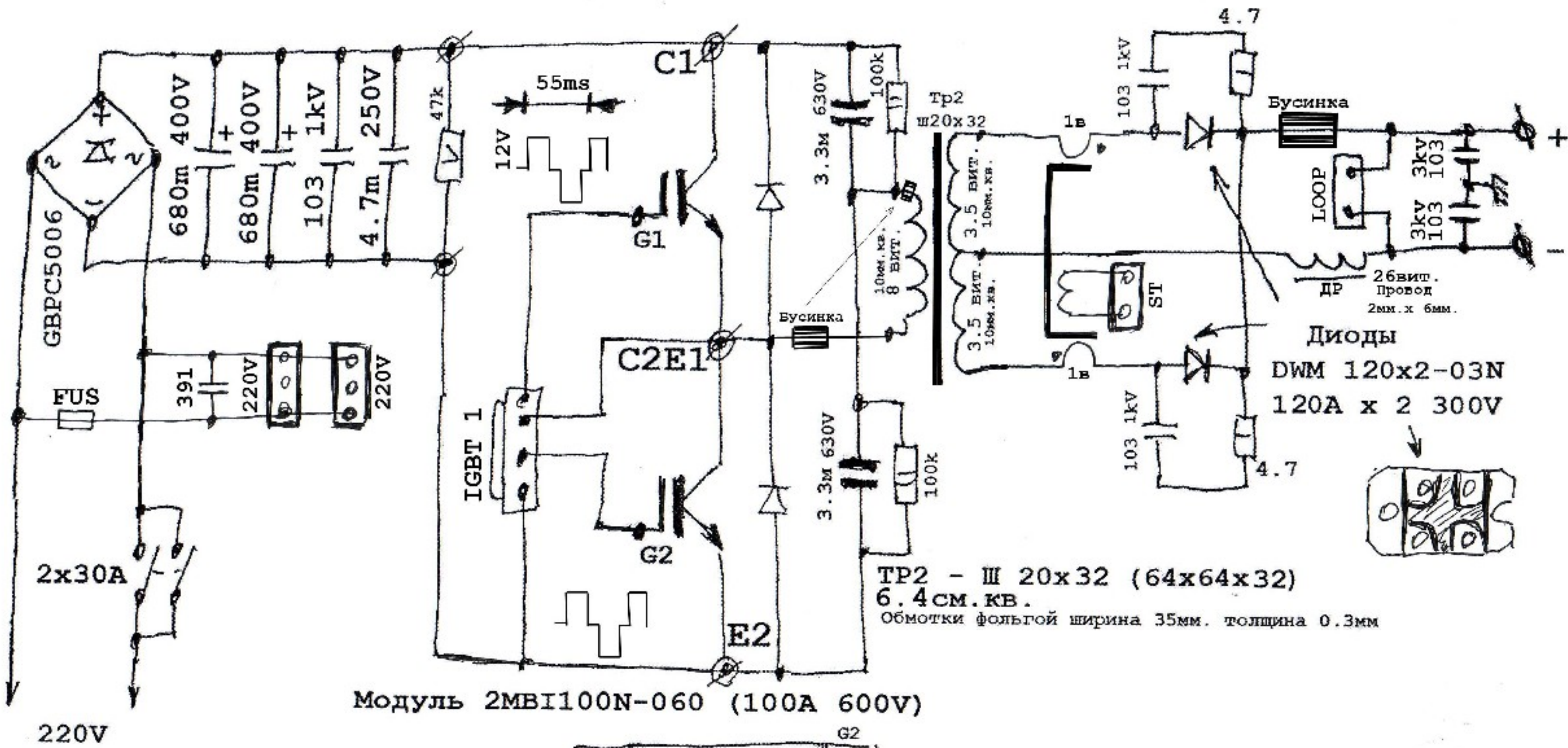

Модуль 2MBI100N-060 (100A 600V)

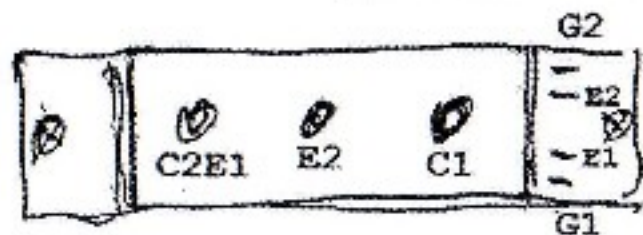

Tr2 - Ш 20x32 (64x64x32)
6.4 см. кв.
Обмотки фольгой ширина 35мм. толщина 0.3мм

04 ноября 2007г.

